

REV.	SPECIFICATION	ECN NO.	APPD.
R1			

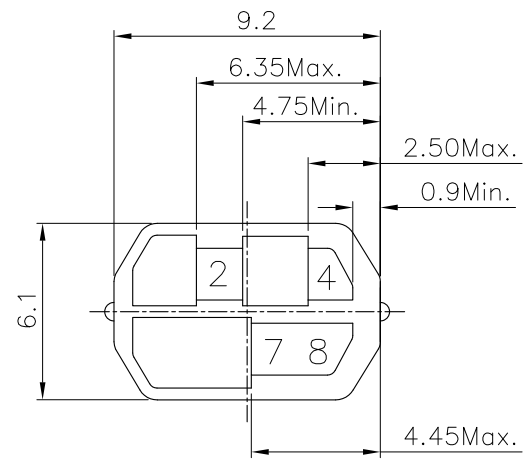

Material:
Housing: 30% Glass Filled PBT UL94V-0.
Electrical Characteristics:
Operating Temperature: -55°C ~ +105°C .
***RoHS Compliant**

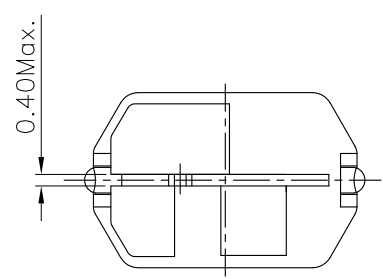
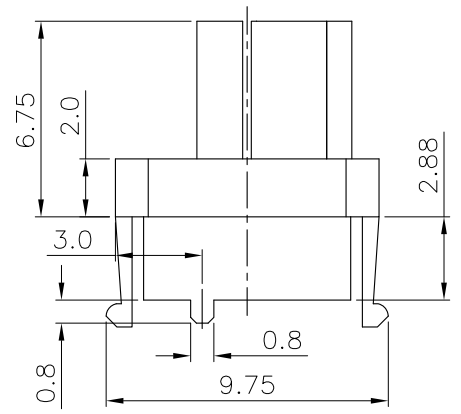
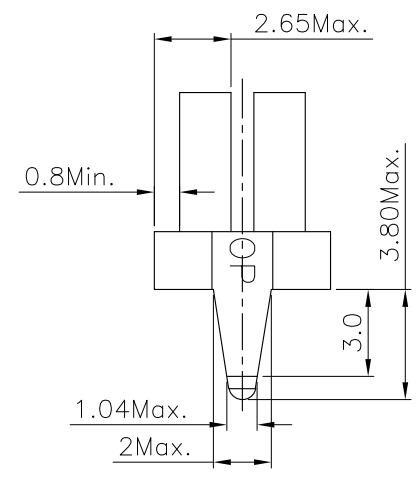

9111- F K 2478 B
Series ——— Female ——— Coding Key ——— Bulk Package ——— Key Position Type

Tolerances	Drawn No.	9111D02008		Title:	
x = ±0.5	Projection	⊕ ⊖		9111 Series	
.x = ±0.25	Unit	mm	Scale	1:1	Female Coding Key
.xx = ±0.15	Drawn By	Liling 01/12'08			

OUPIN			
OUPIN ELECTRONIC(KUNSHAN) CO., LTD.			
P/N: 9111-FK2478B			
SHEET	1/1	Ver.No.	R1